









## Termostato per doccia per montaggio a parete - Champagne spazzolato (Oro 22k)

34 443 979



- rosette scorrevoli Ø 70 mm
- Interasse 150 mm ± 13 mm
- uscita doccetta 3/8"
- con regolatore di portata

Sistema di sicurezza antiriflusso.

	Champagne spazzolato (Oro 22k)	34 443 979-46
	Cromato	34 443 979-00
	Platinato spazzolato	34 443 979-06
	Platinato	34 443 979-08
	Dark Chrome	34 443 979-19
	Ottone spazzolato (Oro 23k)	34 443 979-28
	Nero opaco	34 443 979-33
	Champagne (Oro 22k)	34 443 979-47
	Cromo spazzolato	34 443 979-93
	Dark Platinum spazzolato	34 443 979-99

**Termostato per doccia per montaggio a parete - Champagne spazzolato (Oro 22k)**

34 443 979  
mm [inches]

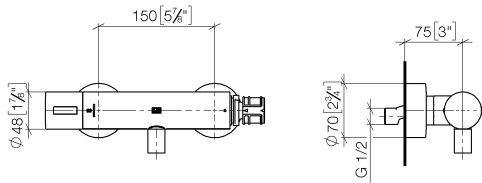

**Diagramma di portata**

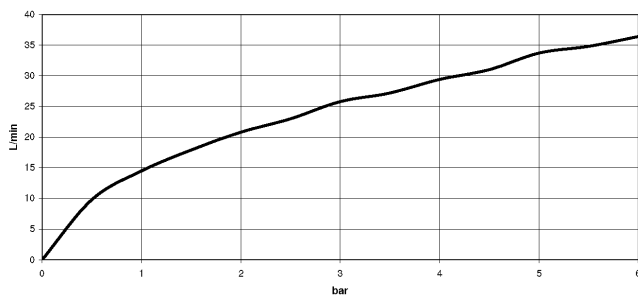

**Certificati**

Belgaqua\_22\_281\_2 LGA\_29986.  
7\_5.

WRAS\_2204005.

## Termostato per doccia per montaggio a parete - Champagne spazzolato (Oro 22k)

34 443 979  
Parts for other  
finishes can be found  
here: Cromato

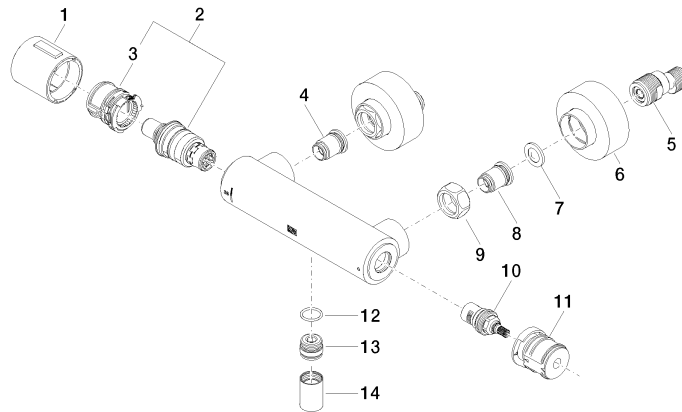

### Elenco delle parti di ricambio

N.	Codice articolo	Denominazione	Quantità necessaria	Tempo di produzione
1	90 17 33 015 00-46	manopola	1	30
2	90 15 02 070 00 90	cartuccia	1	2
3	90 30 40 010 00 90	regolatore	1	2
4	04 31 20 530 00 90	inserto	1	2
5	04 11 04 030 00 90	attacco	2	2
6	90 31 20 512 00-46	rosetta	2	30
7	09 29 30 050 90	setaccio	2	2
8	04 31 20 540 00 90	inserto	1	2
9	09 24 77 008-00	dado	2	10
10	90 90 03 236 00 90	parte superiore	1	2
11	90 30 40 017 00 90	alloggio	1	2
12	90 14 10 010 00 90	guarnizione	1	2
13	09 31 20 511-46	ugello	1	60
14	90 21 02 069 00-46	copertura	1	30